

General Electric contactor suppressor varistor, 400VAC/DC

400 V AC/DC
VDR

Image

Vicarious picture

Approvals**Appropriate contactors**

CL 00, 01, 02, 25
CL 05, 06, 07, 08, 09, 10 (only AC coil voltage)
CWM 9...25
CWM 50...105

Technical Data

Damping factor approx. $1.5 \times UN$
Temperature range $-20...+70\text{ }^{\circ}\text{C}$
Material Flame retardant plastic acc. to (UL 94)
Connection wires Plug contact

Commercial data

Net weight 20
Net weight 20
Weight unit gram
Basic unit pc.
Customs tariff number 85363010
Unit (piece) 1
Limited value 1

Comments

For other configurations and voltages, please inquire

Circuit diagram

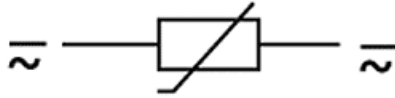

VDR

Dimension drawing

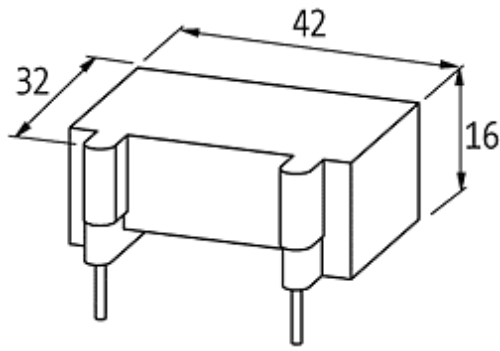

Representante oficial de:



[Argentina – Uruguay – Paraguay – Bolivia – Colombia – y Perú.]



Calle 49 N° 5764 - Villa Ballester (B1653AOX) - Prov. de Buenos Aires - ARGENTINA
Tel: (+54 11) 4768-4242 / Fax: (+54 11) 4849-1212
Mail: ventas@nakase.com.ar / Web: www.nakase.com.ar

