

MSUD valve form A 18mm with cable PVC-JZ 3x0,75 yellow 1,5m

Form A (18 mm)
230 V AC/DC with LED and suppression

Image

Vicarious picture

Approvals**Form**

18061

Technical Data

Operating voltage	230 V AC/DC ±10 %
Operating current per contact (40 °C)	max. 4 A
Switch off spike	<= 490 V
Switch off delay time	<= 20 ms
Housing	Plastic, black (gray on request)
Protection	IP65 and IP67 when plugged and screwed down (EN 60529)
Temperature range	-25...+85 °C, depending on cable quality

Cable

No./diameter of wires	3 × 0.75 mm ²
Wire isolation	PVC (bk, num, gnye)
C-track properties	Max. Externe Vorsicherung 20 A (T) in der Gebäudeinstallation
Jacket	PVC
Outer diameter	approx. 5.9 mm
Bend radius (mobile)	10 x outer diameter
Temperature range (fixed)	-30...+70 °C
Temperature range (mobile)	-5...+70 °C

All data on this data sheet was compiled carefully.

Liability regarding correctness, completeness, and actuality is limited to gross negligence. Created: 06/12

Commercial data

Net weight	119
Net weight	119
Weight unit	gram
Basic unit	pc.
Customs tariff number	85444290
Unit (piece)	1
Limited value	1

Comments

Further cable lengths on request.
Plastic housings with good resistance against chemicals and oils.
The resistance to aggressive media should be individually tested for your application. Further details on request.

Contact layout

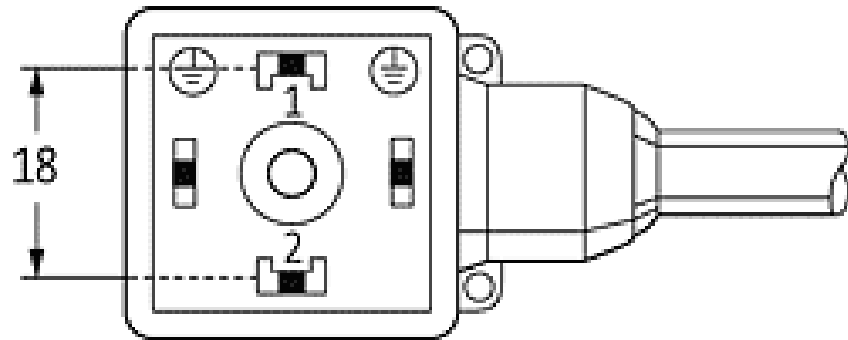

Dimension drawing

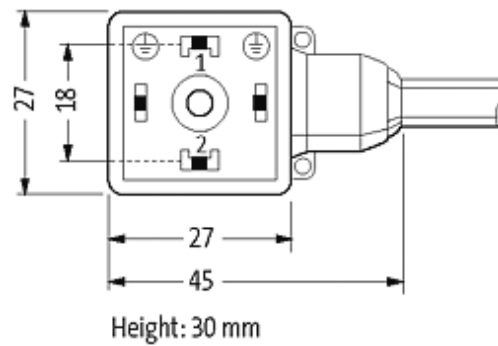

Representante oficial de:



[Argentina – Uruguay – Paraguay – Bolivia – Colombia – y Perú.]



Calle 49 N° 5764 - Villa Ballester (B1653AOX) - Prov. de Buenos Aires - ARGENTINA
Tel: (+54 11) 4768-4242 / Fax: (+54 11) 4849-1212
Mail: ventas@nakase.com.ar / Web: www.nakase.com.ar

