

M12 male straight field-wireable Replaced Art.-No. 27606

Male straight
4-pole
Clamping range cable entry: 6...8 mm

Image

Vicarious picture

Approvals**Express shipments****Form**

12741

Technical Data

Operating voltage	max. 250 V AC/DC
Operating current per contact (40 °C)	max. 4 A
Connection diameter	max. 0.75 mm ²
Clamping range (cable diameter)	6...8 mm
Protection	IP65 and IP67 when plugged and screwed down (EN 60529)
Temperature range	-25...+85 °C

Commercial data

Net weight	27
Net weight	27
Weight unit	gram
Basic unit	pc.
Customs tariff number	85369010
Unit (piece)	1
Limited value	1

Comments

Plastic housings with good resistance against chemicals and oils.
The resistance to aggressive media should be individually tested for your application. Further details on request.

All data on this data sheet was compiled carefully.
Liability regarding correctness, completeness, and actuality is limited to gross negligence. Created: 06/12

Contact layout

Male

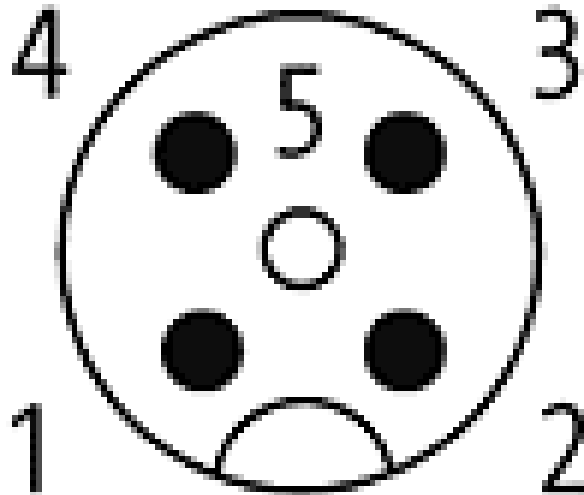

Circuit diagram

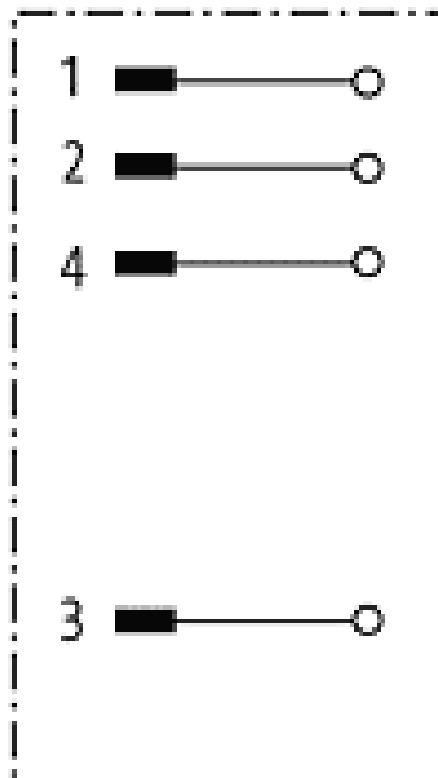

Dimension drawing

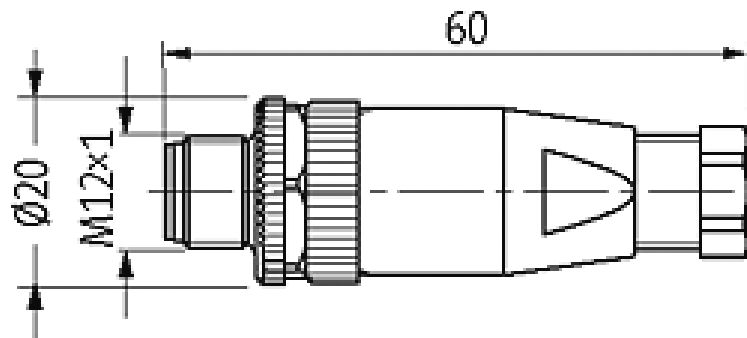

Representante oficial de:



[Argentina – Uruguay – Paraguay – Bolivia – Colombia – y Perú.]



Calle 49 N° 5764 - Villa Ballester (B1653AOX) - Prov. de Buenos Aires - ARGENTINA
Tel: (+54 11) 4768-4242 / Fax: (+54 11) 4849-1212
Mail: ventas@nakase.com.ar / Web: www.nakase.com.ar

