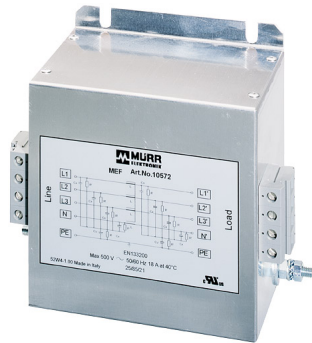

MEF EMC-Filter 3-phase 1-stage with neutral I:100A U:4x500 VAC

Current: 100 A

Image

- with neutral

Vicarious picture

Approvals**Technical Data**

Operating voltage	max. 3 × 500 V AC
Test voltage	L - N: 3.3 kV DC, 2 s; L - L: 3.1 kV DC, 2 s
Operating frequency	50...60 Hz
Consumption at 250 V AC	max. 15 mA
Overload current	18 × IN t < 0.5 ms; 1.5 × IN t < 1 min. (1 × per hour)
Connection diameter	6...35 mm ² single core (AWG 9...2); 10...35 mm ² multiple core (AWG 7...2)

General data

Climatic category	25/85/21 (EN 600068-1)
Mounting method	screw fixing, M10
Dimensions H × W × D	170 x 180 x 140 mm

Description

The 3-phase and one-stage EMC filters MEF 3/1 are used in the range 0.1...30 MHz and dampen interferences found in cables from the mains, supply units and control systems. They are suitable for TN-S, TN-C-S, and TT networks. The best results are obtained with short connection cables (suggestion: earth connection < 10 cm) of the largest possible cross-section. The EMC filters are bi-directional. They reduce symmetrical and asymmetrical interferences that regularly appear with electronically controlled three phase units through mains influences.

Commercial data

Net weight	3400
Net weight	3400
Weight unit	gram
Basic unit	pc.
Customs tariff number	85363030
Unit (piece)	1
Limited value	1

Comments

Attenuation curves on request.

Circuit diagram

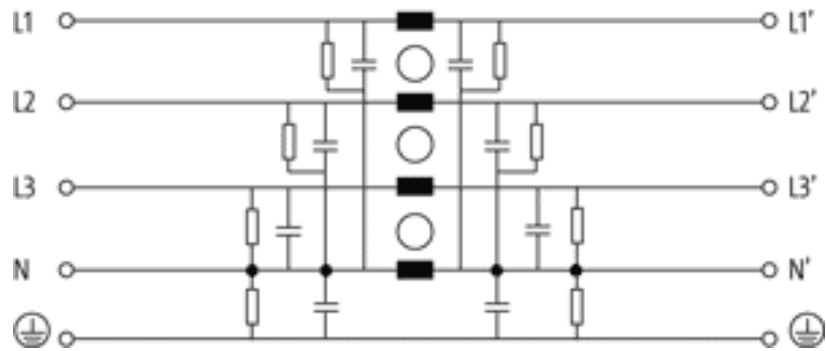

Representante oficial de:



[Argentina – Uruguay – Paraguay – Bolivia – Colombia – y Perú.]



Calle 49 N° 5764 - Villa Ballester (B1653AOX) - Prov. de Buenos Aires - ARGENTINA
Tel: (+54 11) 4768-4242 / Fax: (+54 11) 4849-1212
Mail: ventas@nakase.com.ar / Web: www.nakase.com.ar

